

BILTMOR 5001 WITH CLASSIC LADDER 6003

Contents of the Biltmor box SKU # 5001

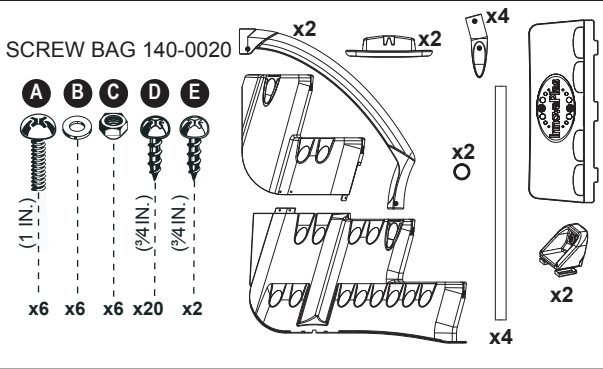

Contents of the ladder box SKU # 6003

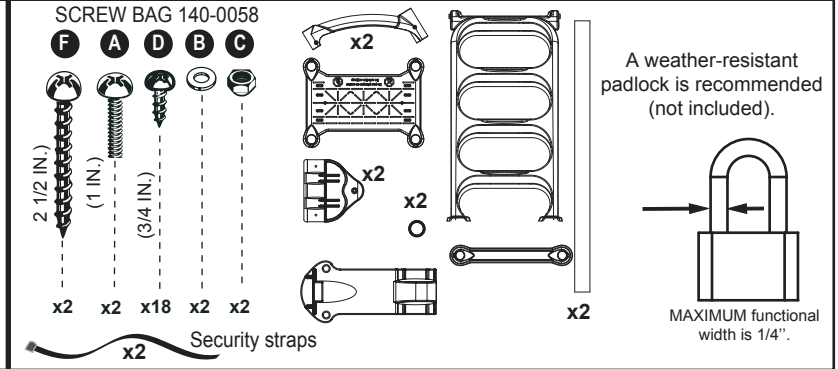

⚠ WARNING

- ▶ Install the step on a flat surface.
- ▶ Do not jump or dive from the step or ladder.
- ▶ Remove the step from water when temperatures drop below freezing.
- ▶ In winter, the step should be stored in an area protected from snow.
- ▶ Never lift the step by its handrails.
- ▶ Use BATTERY operated tools to avoid electric shock near water.
- ▶ Ensure no corrosive materials are added to the step or hardware kit.
- ▶ The step must be installed per manufacturer's instructions.
- ▶ File off all stripped or sharp edges before assembly to avoid injuries and liner damage.
- ▶ The manufacturer is not responsible for damages or injuries caused by improper installation or use of product.
- ▶ To ease the installation of handrails and bolts, use a screwdriver to line up the holes.
- ▶ **Maximum weight: 300 lbs / 135 kg.**

Required tools (not included)

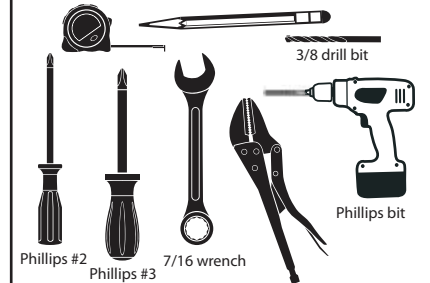

Sand

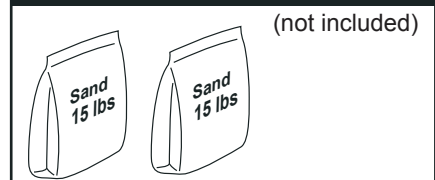

A

- 1) Insert the two gussets in the slots and slide them toward the corners.
- 2) Assemble the two main modules with the six screws, nuts and washers provided.
- 3) Snap the door between the top and bottom module within the slots provided.

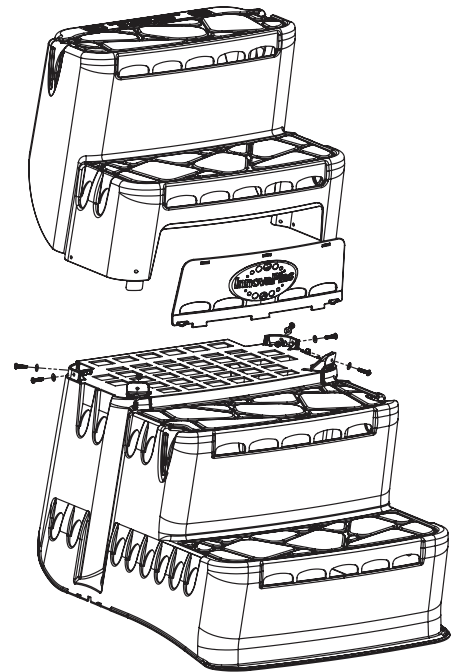
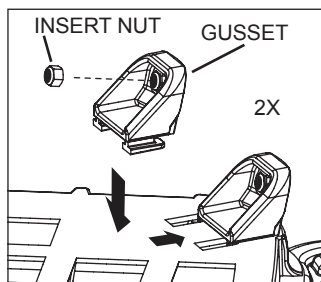
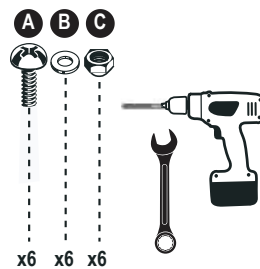

MANUFACTURER WARRANTY

**1 year on step and ladder.
1 year on hardware.**



2257 route 139
Drummondville, Québec
J2A 2G2

WWW.INNOVAPLAS.COM

REV. 02/07/2023

PN:

PG:1

BILTMOR 5001 WITH CLASSIC LADDER 6003

B

1) Snap the four post ends into the step, making sure that the cylindrical part is vertical and that the ends are snapped properly in their respective housings.

2) Snap the two feet to the bottom of the step.

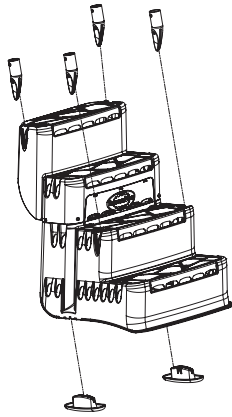

D

1) Insert 2 15 lbs (7 kg) sand bags on either side of the third step, as shown.

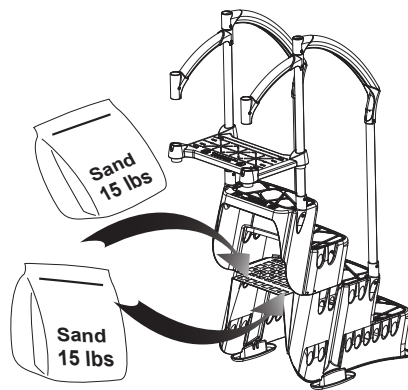

C

1) Insert the four posts into the post ends and secure them in place with the screws provided (see medallion).

2) Insert the platform over the 2 rear posts.

3) Insert the small and large handrails as illustrated. Secure the large handrails with the screws provided. Leave the small handrails floating.

4) Fasten the access panel with the screws provided.

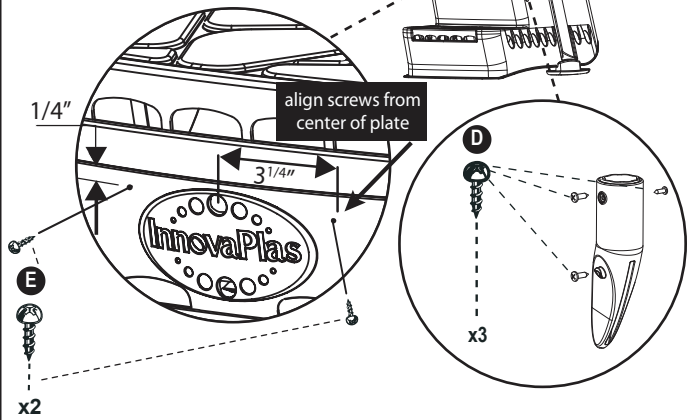

E

1) Slowly submerge the step into the pool. Make sure you do not damage the pool liner in the process.

2) Angle the whole step so that it is entirely under water. Purge all the air from under the step.

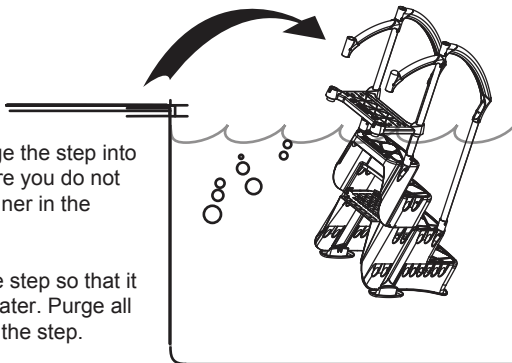

F

1) Once the step is in the pool secure the platform to the top seat (see illustration) using the two straps provided.

Security strap x2

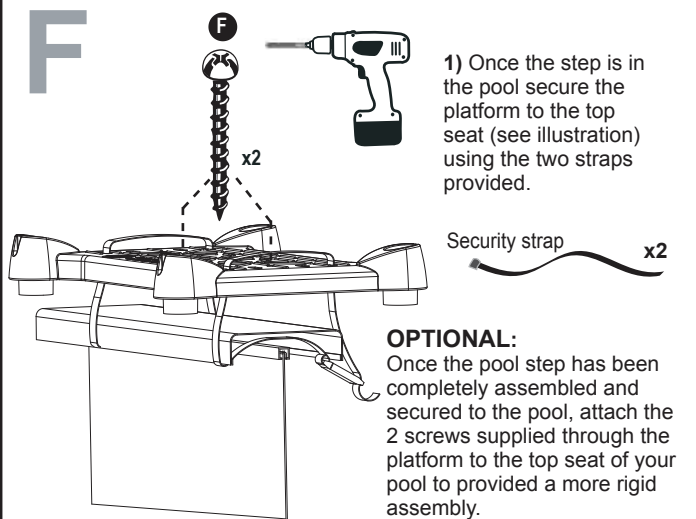

OPTIONAL:
Once the pool step has been completely assembled and secured to the pool, attach the 2 screws supplied through the platform to the top seat of your pool to provided a more rigid assembly.

G

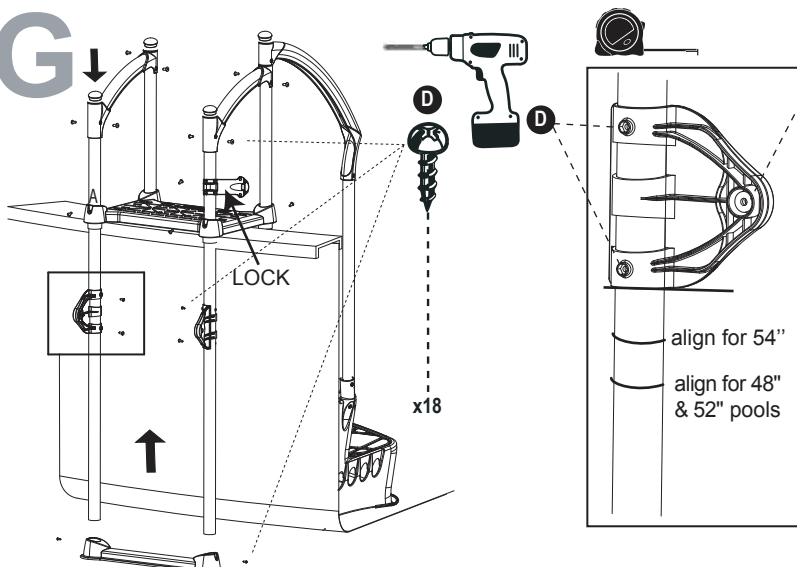

1) Trace a line on each post at 39 inches from the ground for 48" and 52" pools. If you have a 54" pool, trace a line at 40.5 inches from the ground.

2) Slide the pivot blocks onto the posts and line up with the traced marks. Secure with the screws provided.

3) Attach the ladder base to the bottom of the posts with the screws provided.

4) Slide the posts through the platform. Slide the lock over right post between the platform and the handrail. Secure the platform using the screws provided.

5) Slide the posts through the handrails. Insert the post covers into the handrails. If they protrude too much, raise the handrails until the post covers are seated securely on the posts. Secure the short handrails in place with the screws provided.

MANUFACTURER WARRANTY

**1 year on step and ladder.
1 year on hardware.**



2257 route 139
Drummondville, Québec
J2A 2G2

WWW.INNOVAPLAS.COM

REV. 02/07/2023

PN:

PG:2

BILTMOR 5001 WITH CLASSIC LADDER 6003

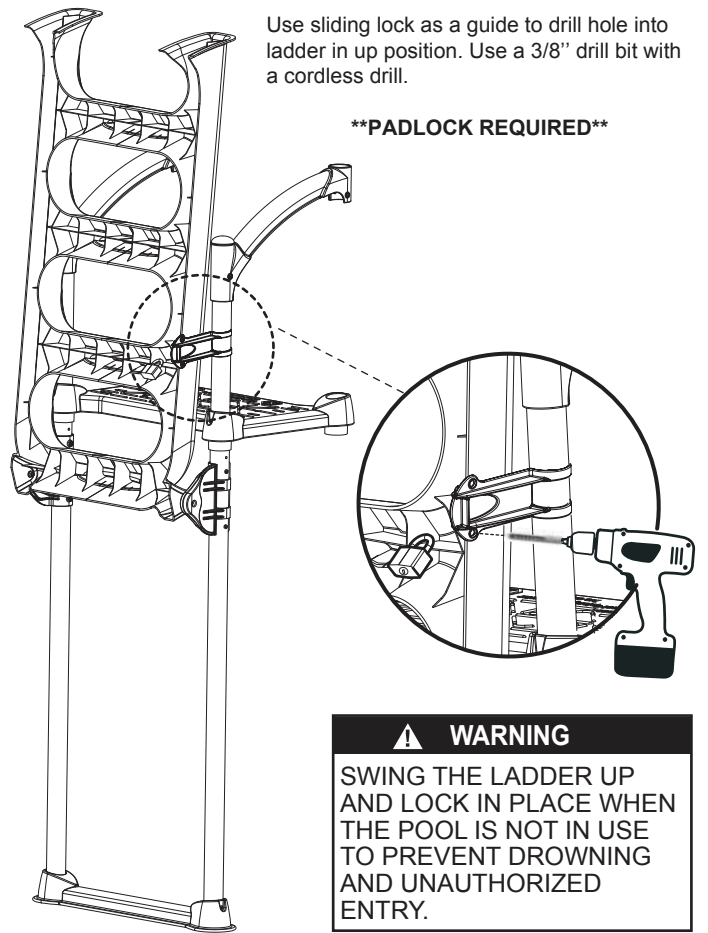
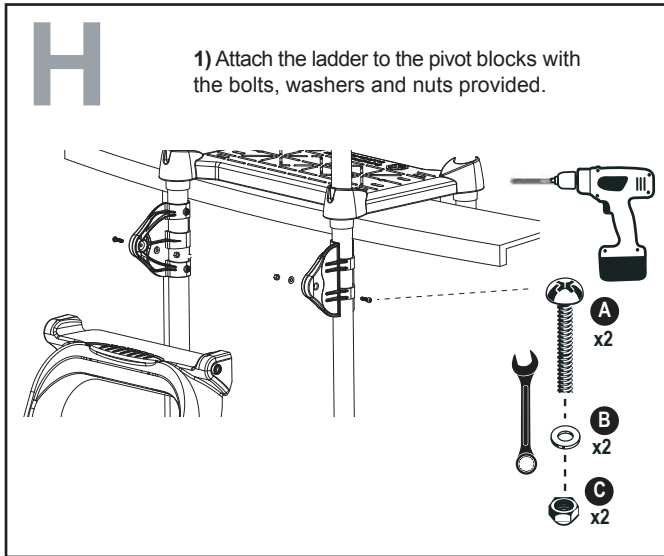

2257 route 139
Drummondville, Québec
J2A 2G2

WWW.INNOVAPLAS.COM

MANUFACTURER WARRANTY

**1 year on step and ladder.
1 year on hardware.**

REV. 07/02/2023

PN:

PG:3